

## OVER 50 YEARS OF CONTINUOUS INNOVATION.

---



Ebco was founded in 1963 as a Tool Room and diversified into mass production of critical components such as Cartridge Links for Ordnance Factories. In 1987, Ebco diversified into furniture hardware and has since become India's leading manufacturer of intelligent home and office furniture fittings.

Today, Ebco's product range spans Office Furniture Fittings, Drawer Slides and Hinges, General Hardware, Joinery Fittings & Screws, Furniture Locks, Retail Display Systems, Window-Door & Glass Hardware, Kitchen Systems & Accessories, Aluminium Profiles & Handles, Bed & Wardrobe Fittings & Accessories, Furniture Lights – LED. Our strengths include a range of core competencies in manufacturing, an ever-widening product range, stringent quality standards, affordable prices and an all-India distribution network.



## INFRASTRUCTURE

We have a state of the art design and product development department which uses the latest 3D design software and CNC Machining Technology. This enables us to launch many new products every month. Our Tool Room capacities have increased significantly which has reduced product development lead time. Our corporate office is located in India's financial capital, Mumbai; we have three manufacturing plants and multiple warehousing facilities north of Mumbai in the towns of Vasai and Palghar, Maharashtra.

Our plants use state-of-the-art roll forming and sheet metal pressing technology. Our products are engineered to perform and our quality department helps ensure that we consistently achieve this goal. Our Quality Assurance Laboratory at the Vasai manufacturing plant performs rigorous cycle tests, load tests and other checks in accordance with certified international quality norms. Our Window Fittings Plant in Palghar has been expanded to increase production capacity and we have commissioned two new warehouses in Palghar which have significantly increased our storage capacity.



Press Shop – Unit 2



Design & Development Dept



Roll Forming Production Line

## PRODUCT RANGE

---

Our products are organised in to 11 verticals under 3 brands, each of which are unique, comprehensive and satisfy a variety of requirements.

### WORKSMART – ERGONOMIC HARDWARE FOR OFFICES

Already a market leader in this category, we continue to offer great products to facilitate better working habits and enhance productivity. Our Office Furniture Fittings segment includes a variety of new Monitor Arms, Smart Lifts – Height Adjustable Desks, Computer Keyboard Stations, CPU Stations, Cable Organisers and other accessories.

### EBCO – SIMPLIFYING LIVES

Known for quality with value for money pricing and a wide range, we truly embody the drive to Make in India – we make almost all products under 7 verticals at our plants here in India. Over the past two years, we have significantly widened our range of products with a special focus on the Architectural Hardware and Window Fittings segments. Our newly introduced products include Pole Shelving System, Furniture Locks, Concealed Drawer Slides, Speciality Hinges, Friction Stays, Door Hinges and more.

### LIVSMART – INTELLIGENT HARDWARE FOR HOMES

Our Kitchen Systems and Accessories segment includes Drawer Systems and Accessories, Corner Solutions, Overhead Systems, Midway Systems, Waste Bins, Roll Top Shutters and more. With a special focus on strengthening our Bedroom Furniture Fittings segment we have widened our range of products which includes Wardrobe Sliding Systems and Accessories, Pro Lift & Electric Bed Fittings and related products.

Our strengths in these segments include our broad product range, best-in-segment quality standards, cutting edge features and fair pricing.



Rain Water Harvesting Tank Below Front Lawn – Unit 1 Vasai



Rooftop Solar Panels at Unit 2 Palghar



Ebco Factory Garden



## CERTIFICATIONS

Quality products, the protection of our environment and nurturing our people have always been our priorities.

As a company, we are BIFMA Compliant. Our manufacturing plant at Vasai houses our Design and Development department, Tool Room, Press Shop, Hardening, Phosphating and Assembly departments and has been certified in ISO 9001: 2015 – Quality Management System, ISO 14001: 2015 – Environmental Management System, ISO 45001:2018 – Occupational Health and Safety Management System.



ISO 9001: 2015 Quality Management Systems  
ISO 14001: 2015 Environmental Management Systems  
ISO 45001 : 2018 Occupational Health and Safety Management Systems

# BIFMA

Our products are BIFMA compliant.



BIS Certification

Bureau of Indian Standards



**LISTED**  
R40012

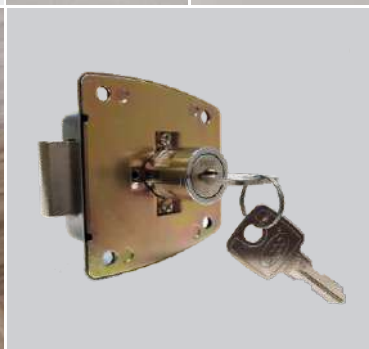
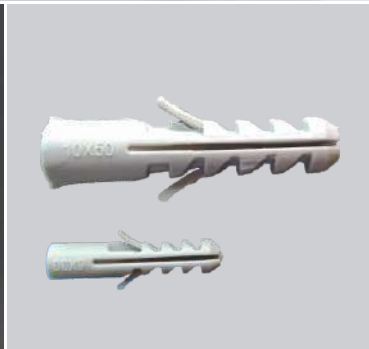
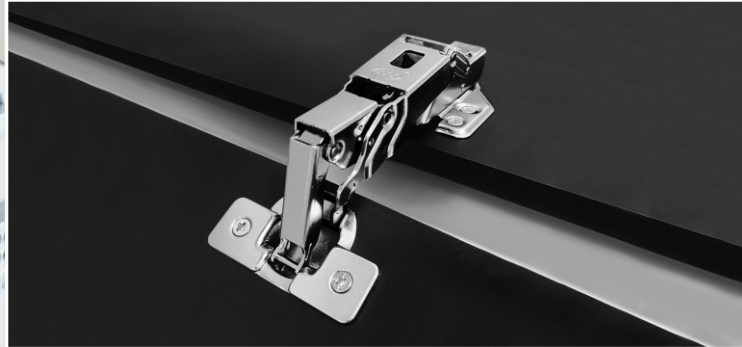



# CONTENTS

DRAWER SLIDES & HINGES ..... 8 - 12

GENERAL HARDWARE .....13 - 17

JOINERY FITTINGS & SCREWS .....18 - 19

FURNITURE LOCKS .....20 - 24

RETAIL DISPLAY SYSTEMS .....25 - 27

WINDOW, DOOR & GLASS HARDWARE .....28 - 38





# DRAWER SLIDES AND HINGES

## DRAWER SLIDES

01

PREMIUM SLEEK TELESCOPIC SLIDES - SOFT CLOSE - 45KG



### WIDEST RANGE:

- Over 600 variations.
- Load Capacity from 10kg to 125kgs.
- Lengths from 200mm to 900mm.

### ADVANCED TECHNOLOGY:

- Available in Regular, Soft-Close & Push-Open.

### CYCLE TESTED:

- As per BIFMA & FIRA norms

03

FULL PANEL WITH 6MM BOTTOM TRACK



04

FULL PANEL QUICK FIT (HT. 54, 86, 125MM)



05

SLEEK TELESCOPIC DRAWER SLIDES - (I) 30



07

SLEEK TELESCOPIC DRAWER SLIDE - (I) 35/45



02

BOTTOM MOUNTING DRAWER SLIDES



06

SLEEK TELESCOPIC DRAWER SLIDES - 35KG



08

SLEEK TELESCOPIC DRAWER SLIDE - (I) 35 - SOFT CLOSE



09

SLEEK TELESCOPIC DRAWER SLIDE - (I) 35 - PUSH OPEN



01 - Size (L):300, 350, 400, 450, 500, 550, 600 mm. Load Capacity: 45kgs Finish: Zinc White. 02 - Size: 300, 350, 400, 450, 500 mm. Load Capacity: 20kgs Finish: Ivory, Brown & Black. 03 - Size (H): 54mm & 86mm (L): 350-500mm. Size (H): 125mm (L): 350, 400, 450, 500mm. Size (H): 150mm (L): 350-500mm. Load Capacity: 25kgs. Finish: Ivory 04 - Size (H): 54, 86, 125mm (D): 400mm (W): 400, 450mm Load Capacity: 25 kgs Finish: Ivory 05 - Size 250, 300, 350mm. Finish: Zinc White Size 400, 450, 500mm. Finish: Zinc White/Zinc Black Load Capacity: 30kgs. 06 - Size (L): 350, 400, 450, 500, Load capacity : 35 Kgs. Finish: Zinc White/Zinc Black. 07 - Size For 35 Kgs (L): 200, 250, 300, 350, 400, 450, 500, 550, 600mm. Finish: Zinc White/Zinc Black. Size (L): 750, 900mm. Finish: Zinc White. Size For 45 Kgs (L): 250, 300, 350, 400, 450, 500, 550, 600, 750, 900mm. Finish: Zinc White/Zinc Black. 08 - Size (L): 300, 550, 600 mm. Finish: Zinc White. Size (L): 350, 400, 450, 500 mm. Load Capacity: 35kgs. Finish: Zinc White/Zinc Black. 09 - Size (L): 350,400,450,500mm. Load Capacity : 35Kgs. Finish : Zinc White.



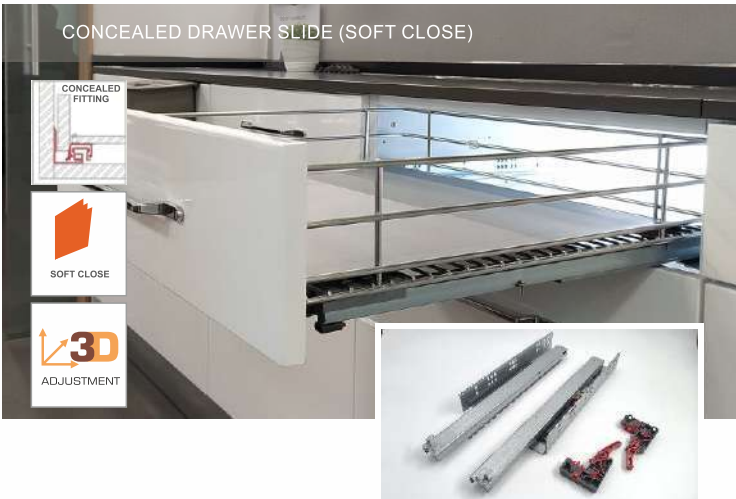

**FEATURES**

- Highly stable and uses minimal space below the drawer (27mm clearance).
- Available with fascia bracket for wooden drawers and without fascia bracket for undermount kitchen baskets.
- Flexible 3D adjustment allow fascia brackets to adjusted in 3 directions.

- Size (L) : Push Open : 350, 400, 450, 500mm  
Soft Close : 300, 350, 400, 450, 500, 550, 600mm  
For Kitchen Baskets (w/o fascia bracket) : 500mm
- For Undermount Kitchen Baskets : 450mm
- Load Capacity : 35Kgs
- Finish : Zinc White



- 11** - Size (L) : 400, 450, 500mm. Load Capacity: 35kgs. Finish: Stainless Steel.
- 12** - Size (L): 400, 450, 500mm. Load Capacity: 35kgs. Finish: Stainless Steel
- 13** - Size (L): 400, 450, 500, 550mm. Load Capacity: 35kgs. Finish: Zinc White.
- 14** - Size (L): 450, 500, 600, 750, 900 mm. Load Capacity: 90kgs. Finish: Zinc White.
- 15** - Size For 125kg. (L) 450,500,550,600,750,900mm. For 90kg. (L) 1050,1200mm.. Finish: Zinc White.



- 16** - Size (L): 250mm. Load Capacity: 12kgs. Finish: Black.
- 17** - Size (L): 350. Load Capacity: 35kgs. Finish: Zinc White/Zinc Black.
- 18** - Size (L): 350 mm. Load Capacity: 12kgs. Finish: Zinc White/Zinc Black.
- 19** - Size (L): 200, 300, 375mm. Load Capacity: 12kgs. Finish: Zinc White/ Zinc Black.



# DRAWER SLIDES AND HINGES

## HINGES

### SPECIALITY HINGES

**01** E SOFT LINEAR HINGE – 3D



**02** 125° HINGE - SOFT CLOSE



**03** 155° HINGE - ZERO PROTRUSION (SOFT CLOSE)

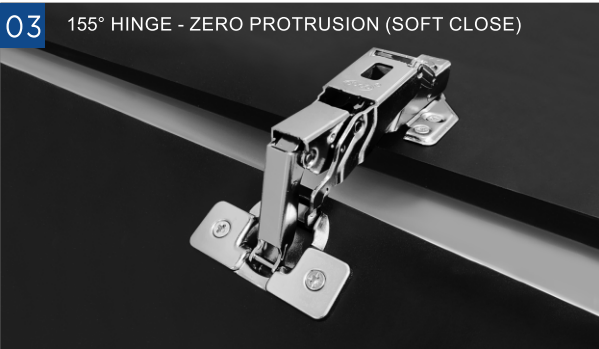

**04** THICK DOOR HINGE 15-35MM SOFT CLOSE /  
**05** THICK DOOR HINGE 15-35MM (WITH 3D MOUNTING PLATE)



Mounting Plate

**06** THICK DOOR HINGE - SOFT CLOSE



**07** THICK DOOR HINGE



**08** MINI HINGE



**09** FOLDING DOOR HINGE /  
FOLDING DOOR HINGE (I)



**10** BLIND CORNER HINGE 3D-SC



**11** BLIND CORNER HINGE - EURO



**01** - Max Opening: 105°. Shutter Size: 35" x 24" (900mm x 600mm) for 2 hinges. Shutter Thickness: 14 to 22mm. Shutter Cavity: Ø35mm, 11.4mm deep. Finish: Nickel plated & Titanium. **02** - Max opening: 125°. Shutter size: 34" x 22" (850 mm x 550 mm) for 2 hinges. Shutter Thickness: 16 to 19mm. Shutter cavity: Ø35mm, 13mm deep, cavity 4mm from edge. Finish: Nickel plated. **03** - Max Opening: 155°. Shutter Cavity: Ø35mm, 11.5mm deep. Shutter Thickness: 14 to 24 mm. Cabinet Side panel Thickness: 17-21 mm. **04** - Shutter Cavity: Ø35mm. Max Opening: 95°. Shutter Thickness: 15 to 35mm. Available with 3D mounting plate. **05** - Shutter Cavity: Ø35mm. Max Opening: 95°. Shutter Thickness: 15 to 35mm. Available with 3D mounting plate. **06** - Max Opening: 95°. Shutter Size: 34" x 22" (850mm x 550mm). Shutter Thickness: 18 to 30mm. Shutter Cavity: Ø40mm, 14mm deep, 4mm from edge. **07** - Max Opening: 100°. Shutter Size: 34" x 22" (850mm x 550mm). Shutter Thickness: 18 to 30mm. Shutter Cavity: Ø40mm, 14mm deep, 4mm from edge. **08** - Max Opening: 100°. Shutter Size: 24" x 18" (600mm x 450mm). Shutter Thickness: 12 to 18mm. Shutter Cavity: Ø26mm, 10mm deep, 4mm from edge. **09** - Ø35mm. Max Opening: 180°. Shutter Thickness: 15 to 23mm / Hinge (I): 16 to 26mm. **10** - Ø35mm. Max Opening: 90°. Shutter Thickness: 16 to 19mm **11** - Max Opening: 105°. Shutter Size: 34" x 22" (850mm x 550mm). Shutter Thickness: 16 to 19mm.



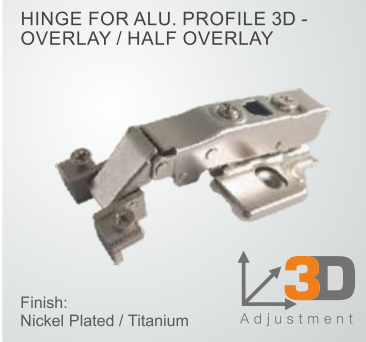

**12** - Max Opening: 100°. Shutter Size: 34" x 22" (850mm x 550mm). Shutter Thickness: 16 to 19 mm. **13** - Shutter Cavity: Ø35mm. Max Opening: 100°. Shutter Thickness: 16 to 19mm. **14** - Max Opening: 100°. Shutter Size: 34" x 22" (850mm x 550mm) for 2 hinges. Shutter Thickness: 16 to 19mm. Shutter Cavity: Ø35mm, 12mm deep, 4mm from edge. **15** - Max. opening : 270°. Shutter size : 34" x 22" (850mm x 550mm) for 2 hinges. Shutter cavity : Ø35mm, 12mm deep. Shutter Thickness: 16 to 19mm. **16** - Max Opening: 105°. Shutter Size: 34" x 22" (850mm x 550mm). Shutter Thickness: 16 to 19 mm. **17** - Max. opening : 100°. Shutter size : 600mm x 350mm for 2 hinges. Shutter Thickness: 4 to 6mm. Shutter Cavity: Ø26mm, 4mm from edge. **18** - Max. opening : 105°. Max Shutter size : 600mm x 400mm for 2 hinges. Shutter Thickness: 4 to 6mm. Shutter cavity : Ø35mm, 4mm from edge. **19** - Max Shutter Size: 800mm x 350mm. Glass Shutter Thickness : 4 to 6mm. • Built in catch for flush fitting glass shutters. **20** - Max Opening: 165°. Shutter Size: 85" x 24" (2135mm x 600mm). Shutter Thickness: 16 to 26 mm. Shutter Cavity: Ø35mm, 12mm deep, 4mm from edge. **21** - • Ideal for folding shutters. Finish: Black. **22** - • Ideal for steel cabinet. • Spring loaded latch mechanism for long lasting use. **23** - Max Load: 2.6 Kgs/set. Finish: SS 304. **24** - Glass Thickness: 6 to 10 mm. Min. Ply Thickness: 18 mm. **25** - Finish: Titanium.



### 26 CABINET HINGE



### 27 SPRING LOADED HINGE



### 28 CRANKED HINGE



### SOFT CLOSE / PUSH OPEN HINGES

### 29 EURO SLOW MOTION HINGE - 2 HOLE/ 4 HOLE MOUNTING PLATE



### 30 HINGE SLOW MOTION - 2 HOLE/ 4 HOLE MOUNTING PLATE



### 31 HINGE SLOW MOTION - 3D

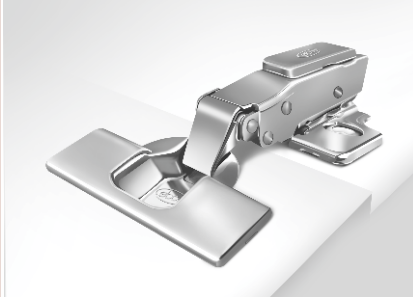

### 32 HINGE PUSH OPEN



### SS 304 HINGES

### 33 EURO SLIP ON HINGE SS 304 WITH 4 HOLE MOUNTING PLATE



### 34 HINGE SLOW MOTION - SS304 WITH 4 HOLE MOUNTING PLATE



### 35 SHORT ARM HINGE WITH 4 HOLE MOUNTING PLATE - SS304



### PRIMARY SERIES

### 36 SLIP ON HINGE - EURO / SLIP ON HINGE EURO WITH 4 HOLE MOUNTING PLATE / 4 HOLE (30mm)



### 37 CLICK ON HINGE (I) / CLICK ON HINGE (I) WITH 4 HOLE MOUNTING PLATE



### HINGE ACCESSORIES



DOWEL FOR HINGE - EURO



Ø 35MM COVER CAP

**26 - Max Opening:** 180°. Horizontal and Vertical Adjustments provided. **Finish:** Anthracite, White Mat, Silver. **27 - Max Opening:** 180°. **Finish:** Black, Brown. **28 - Max Opening:** 180°. **Max Shutter Size:** 34" x 22" (850mm x 550mm). **Plate Recess Depth :** 1.5mm. **29 - Max Opening:** 105°. **Shutter Size:** 34" x 22" (850mm x 550mm). **Shutter Thickness:** 16 to 19mm. **Shutter Cavity:** Ø35mm, 12mm deep, 4mm from edge. **30** Ø35mm. **Max Shutter Size:** 34" x 22" (850mm x 550mm) for 2 hinges. **Shutter Thickness:** 16 to 19mm. **31 - Max Opening:** 105°. **Shutter Size:** 34" x 22" (850mm x 550mm) for 2 hinges. **Shutter Thickness:** 16 to 19mm. **Shutter Cavity:** Ø35mm, 12mm deep, 4mm from edge. **32 - Max. Opening:** 105°. **Shutter Size:** 34" x 22" (850mm x 550mm) for 2 hinges. **Shutter Thickness:** 16mm to 19mm. **Shutter cavity:** Ø35mm, 12mm deep, 4mm from edge. **33 - Max Opening:** 105°. **Shutter Size:** 34" x 22" (850mm x 550mm). **Shutter Thickness:** 16 to 19mm. **Shutter Cavity:** Ø35mm, 12mm deep, 4mm from edge. **34 - Max. opening:** 105°. **Shutter size:** 34" x 22" (850 mm x 550 mm) for 2 hinges. **Shutter thickness:** 16 to 19mm. **Shutter cavity:** Ø35mm, 12mm deep, cavity 4mm from edge. **35** Ø35mm. **Max opening:** 100°. **Shutter Thickness:** 16 to 19mm. **36 - Max opening:** 105°. **Shutter size:** 34" x 22" (850mm x 550mm) for 2 hinges. **Shutter Thickness:** 16mm to 19mm. **Shutter cavity:** Ø35mm, 12mm deep, 4mm from edge. **Available in 4 hole mounting plate/4 hole mounting plate (30mm).** **37 - Ø35mm. Max Opening:** 105°. **Shutter Size:** 34" x 22" (850mm x 550mm) for 2 hinges. **Shutter Thickness:** 16 to 19mm.





# GENERAL HARDWARE



## TABLE BRACKETS

- These table brackets are ideal space saving solution for fold away table or shelf where space is limited.
- Suitable for multipurpose applications for home, offices, retail stores, etc.
- Available with special release knob feature that folds when not in use.
- Available in various options - Table Bracket Mini, Recessed, With Damper and more.

01 TABLE BRACKET MINI

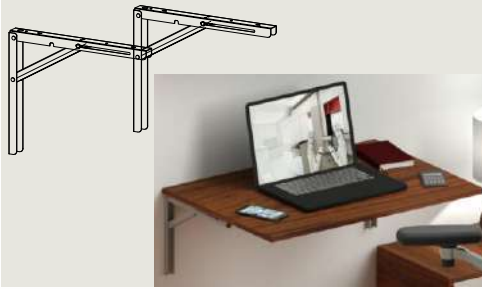

02 TABLE BRACKET RECESSED



03 TABLE BRACKET



04 TABLE BRACKET DAMPER



05 TABLE TOP FOR TABLE BRACKET



06 FOLDING TABLE MOUNT



13 PRO LIFT SOFT CLOSE



14 PRO-LIFT / PRO LIFT PROGRESSIVE



15 PRO LIFT HEAVY DUTY



07 FOLDING BRACKET 350 & 450



08 FOLDING UTILITY TABLE



09 AC MOUNTING BRACKET



10 MULTI UTILITY FOLDING BRACKET



11 TABLE LIFT - 200 WITH DAMPER



12 TABLE LIFT 300 - WITH DAMPER



**01** - Size: 225, 325mm. Max. load: 80kgs. Finish: Brown/ Anthracite / White Matt. **02** - Size: 300, 400, 500mm. Max. Load: 100 kgs. Finish: Anthracite / White Matt. **03** - Size: 300, 400, 500, 600mm. Max. load: 100kgs (300/400/500mm) & 150kgs (600mm). Finish: Anthracite/ Brown/White Matt. **04** - Size: 200, 400mm. Max. Load: 20N & 40N. Finish: Anthracite. **05** - Size (mm): 400(D) x 600 (W) x 18(T) Compatible with Table Bracket TB30; 500(D) x 700(W) x 18(T) Compatible with Table Bracket TB40; 575(D) x 800 (W) x 18(T) Compatible with Table Bracket TB50. Finish: Frosty White/Walnut. **06** - Size: Ø76mm, 154 x 154mm. Finish: Black. **07** - Size: 350x60x22mm, 450x60x22mm. Finish: Anthracite / White Matt / Brown. **08** - Size: 600, 750, 900 & 1200mm. Max. Load: 70 kgs. Finish: Anthracite. **09** - Size: 500mm. Max. Load: 120 kgs. Finish: White Texture. **10** - Size: 340mm - 500mm. Max. Load: 120 kgs. Finish: Black. **11** - Load Capacity: 11 kgs. max. Recommended Table Size: 4 x 2 feet. Lift up by 200mm. Finish: Table Lift 200- Black/Anthracite. Table Lift 200 with Damper - Anthracite. **12** - Load Capacity 11 kgs. max. Recommended Table Size: 4 x 2 feet. Lift up by 300mm. Finish: Table Lift 200- Black/Anthracite. Table Lift 300 with Damper - Anthracite. **13** - Force: 60N, 80N, 100N, 120N, 150N. Finish: Grey. **14** - Finish: Silver. Force: 60N, 80N, 100N, 120N, 150N, 200N & 250N. **15** - Finish: Anthracite. Force: 250N, 300N, 350N.



# GENERAL HARDWARE

**16** CABINET STAY

PLINTH BASE - ADJUSTABLE

Load Capacity: 500kgs  
Finish: Zinc Yellow

**23** SOFA BASE

332 333  
282 283

**17** CABINET STAY - HEAVY

PLINTH SCREWS

Plinth Screw - BB

Plinth Screw

**24** PEDESTAL CASTOR/ PEDESTAL CASTOR RECESSED

PC 28 PCR 35 PCR 60

**18** LID STAY

**20** BALL HEAD PLINTH SCREW

BHP-870 BHP-840

**21** BASE PLINTH

BP 616 BP 1418

CABINET SHELF SUPPORT

CSS 1 CSS 1N CSS 2

PIN SHELF SUPPORT

PSS 1 PSS 2

**19** FLAP STAY

FURN FELT

With Pin/Adhesive

PLINTH BUSH

PLINTH BUSH WITH PIN **22** PLINTH PIN

**25** ADJUSTABLE GLASS SHELF SUPPORT

AGSS1/2 AGSS3 AGSS4

**16** - Max. Load: 2kgs (1 stay), 4.5kgs (2 stays). Finish: Plated. **17** - Max. Load: 6kg (1 stay), 13.3kgs (2 stays). Finish: Nickel Plated. **18** - Finish: SS304 **19** - Size: Regular (180mm) / Large (230mm)/ Ex-Large (280mm). Finish: Plated/ Brown. Load: 12kgs. **20** - Load Capacity: 800kgs/ piece. **21** - Load Capacity: BP 616 - 1000kgs / piece, BP 1418 - 1200kgs / piece. **22** - Size: 15(D) x 8(H) x 6mm (nail). Finish: White/Black. **23** - Easy to mount foot base for sofas and cabinets. Size: SB332: 70x70x45mm, SB333: 70x70x75mm, Finish: Brown. SB282: 45x200x45. SB283: 45x200x75. Finish: Chrome Plated. Load Capacity: 500kg/pc. **24** - For PC28: Load Capacity: Static - 500kgs, Dynamic - 300kgs. Set Height: 28mm, For PCR35: Load Capacity: 400kgs, Set Height: 5 & 7mm. Finish: Black. **25** - AGSS1/2 - Size: 6mm - 12mm. Finish: Silver/Nickel Plated Satin. AGSS3 - Size: 5mm - 15mm, AGSS4 - Size: 3mm - 20mm. Finish: Chrome Plated/Nickel Plated Satin. **26** - Size: 8mm, 10mm, 12mm. Finish: Nickel Plated Satin

GLASS SHELF SUPPORT & GLASS SHELF SUPPORT (SCREW)

GSS 1 GSS 2 GSS 3

**26** GLASS SHELF BRACKET





UTILITY SHELF BRACKET

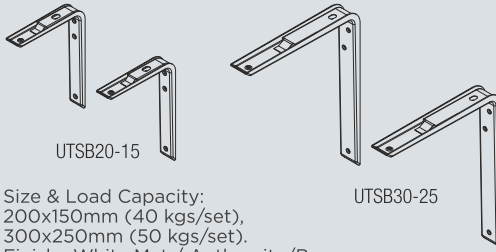

Size & Load Capacity:  
200x150mm (40 kgs/set),  
300x250mm (50 kgs/set).  
Finish: White Mat / Anthracite/Brown.

35 VENTILATION GRILL - RECTANGULAR



Kitchen



Dressing Table



Study Room



Balcony Garden

36 CUPBOARD LATCH

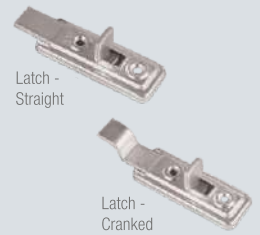

Latch - Straight

Latch - Cranked

27 WALL SHELF ROD - HD



MIRROR HOLDER



33 SPRING CLIP



Cupboard

37 TONGUE HANDLE



28 WALL SHELF ROD ADJUSTABLE



30 GLASS CORNER HOLDER / GLASS CORNER HOLDER - ECO



Corner Holder

Corner Holder - Eco

34 VENTILATION GRILL - DIA 40MM



38 GLASS HANDLE



29 WALL SHELF ROD

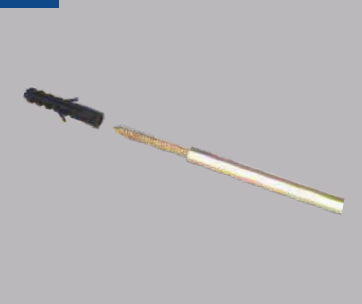

31 GLASS SIDE HOLDER



32 GLASS CLAMP



27 - These are heavy duty, plastic cover moulded, built in with plug and with better grip. Size: Ø10 x 100, Ø10 x 145, Ø14 x 140. Finish: Brown. 28 - Size: 150, 200, 250mm. Finish: Zinc Plated White. 29 - Size: 100mm, 150mm. Finish: Zinc Plated Yellow. 30 - Size: 4mm. Finish: Ivory/Clear. 31 - Size: 4mm. Finish: Ivory/Clear. 32 - Size: 4mm. Finish: Clear. 33 - Max. Shutter Size: Cupboard: 2000x750mm (80"x30"). Max. Load Capacity: 3.5kgs. Finish: Zinc Plated White. 34 - Finish: Black/Grey/White. 35 - Size: 34 X 168mm. Finish: Black/Grey/White. 36 - Size: 56, 96, 150mm. Finish: Zinc Plated Black & White/SS304. 37 - Size: 50x40mm, 82x40mm. Finish: Black/Brown/Silver/White Matt. 38 - Finish: Chrome Plated. Glass Shutter Thickness: 4-6mm



# GENERAL HARDWARE

## CABINET HANGER CONCEALED

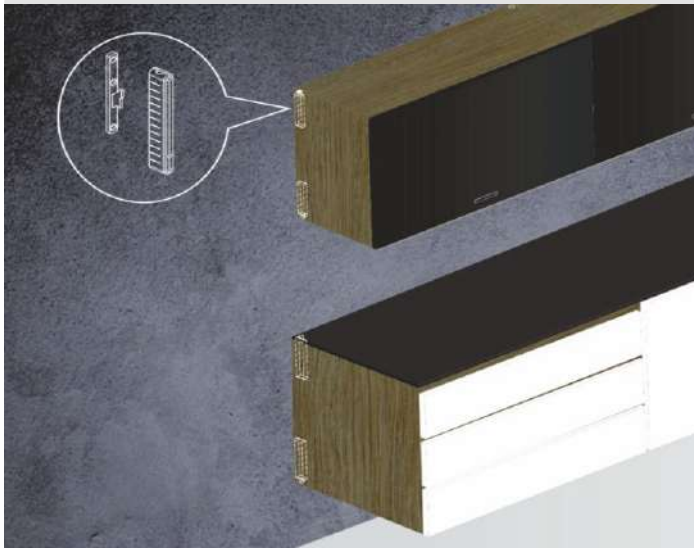

- Heavy duty cabinet hanger.
- Ideal for kitchen cabinets (base unit & wall units)
- Bathroom vanity units & similar applications.
- Size: 141x 21mm.
- Load Capacity: 300kgs/pair.
- Min. Panel Thickness: 18mm.
- Finish: Mocha.
- Slides in for easy storage.



## 40 HANGER BRACKET



## 41 HANGER BRACKET - HEAVY DUTY



## 42 HANGER / HANGER PLATE



## 43 ADJUSTABLE CORNER BRACKET



## 44 PANEL CATCH

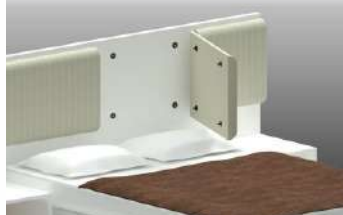

## BUMPERS



**SAFETY CORNER BUMPER S**  
SCBS35  
Size: 35X35X25mm



**SAFETY CORNER BUMPER R**  
SCBR41  
Size: 41X41X15mm



**SAFETY DOOR SPACER**  
SDS 2560  
Size: 88X70X22mm



BS1-7



BS1-18



BS1-29



BS1-19



BS2-1



BS2-5



BS2-20

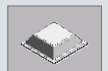

BS2-32



BS2-6



BS2-34



BS2-35



CB-5

## 45 DOOR SEAL PROFILE

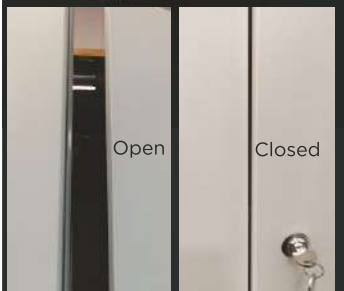

## 39 BAG HOOK

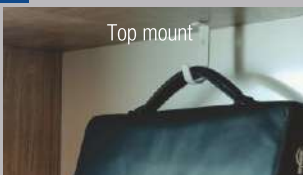

Top mount



Side mount

## CABINET HANGER BRACKET



Size: 48x43x33mm  
Finish: White / Brown

39 - Ideal for hanging bags, helmets etc. beneath the table. Easy to mount under or on the side wall of desk. **Size:** 100x20x3mm. **Finish:** White. **40 - Size:** Regular/ Mini. **Load Capacity:** 45kgs (Regular), 30kgs (Mini). **Finish:** Black/Anthracite. **41 - Size:** 60 x 59 x 10mm. **Load Capacity:** 150kgs. **Finish:** Zinc Plated Yellow. **42 - Size:** For Hanger - 60mm, 80mm, 100mm. **Load Capacity:** 80 kgs/piece. **Size:** For Hanger Plate - 46mm. **Load Capacity:** 80 kgs/piece. **43 - Load Capacity:** 60 kgs/piece. **Finish:** Plated / White. **44 - Ideal** for joining multiple panel installations. **Size:** Ø32 x 25.5mm. **Finish:** Black. **45 - Finish:** Silver/Anthracite. **46 - Size:** 76x64x2mm **Load Capacity:** 150kg, **Finish:** Zinc Yellow.

## 46 SOFA CONNECTORS





**47** DOOR STIFFNER- CONCEALED

CUTTER FOR DOOR STIFFNER- CONCEALED

**55** WARDROBE LATCH

**55** MULTI CORNER BRACKET

**AUTO BOLT LATCH**

**48** DOOR STIFFNER HD

**52** BED CLAMP

**56** TURN TABLE MECHANISM

TTM1H-4  
Load: 35Kg  
Size:94.5 x 94.5mm

TTM2-9  
Load: 120 Kg  
Size:Ø230mm

TTM2-12  
Load: 160kg  
Size:Ø304mm

TTM3G-8  
Load: 25Kg  
Size:Ø202mm

TTM3G-14  
Load: 30Kg  
Size:Ø300mm

For Glass

**59** DOOR WEDGE

**MAGNETIC CATCH- DOT**

**53** BED CROSSBAR CLAMP / TELESCOPIC

**57** PUSH OPEN FITTING - MAGNETIC

12 mm      40 mm

**60** MAGNETIC CATCH-ULTRA SLIM

**49** DOOR STIFFNER

POZI/PHILIPS SCREW DRIVER BIT (MAGNETIC)

POZI/PHILIPS SCREW DRIVER BIT (MAGNETIC)

Two Way-Magnetic

**58** PUSH OPEN FITTING MAGNETIC RECESSED

MC-US1      MC-US1L

MC-US2      MC-US2L

MC-I1      MC-I1L

**50** COVER FOR DOOR STIFFNER

**54** CARBIDE STANDARD SHANK

**CORNER CLAMP**

**51** SLIDING CABINET SHUTTER FITTING

**UTILITY CORNER BRACKET**

Size: 84 x 84mm  
Finish: Zinc Plated Yellow

**47** - Length: 2000mm (For Door Height 1600-2000mm). Length: 2400mm (For Door Height 2000-2400mm). **48** - For Door Height 1000-2700 mm. **49** - Size: 2010mm. Finish: Aluminium/Black. **50** - Size: 6mm. Finish: Opaline/ Silver. **51** - Finish: White/Brown. **52** - Size: 4" and 6". Load/Set: 1200kgs. Finish: Zinc Plated Yellow. **53** - Size: 140x64mm. Finish: Zinc Plated Yellow. **54** - Size: 38x38x 38mm. **55** - Size: 165x165x 35mm. Finish: Black/White Matt/Anthracite. **56** - Size: 100, 150, 200mm. Load Capacity: 50 kgs, 75 kgs, 100 kgs. **57** - Stroke: 12mm/ 40mm. Push Force/Piece: 3.5kgs (12mm), 3kgs (40mm). Finish: Grey / Black. **58** - Stroke: 38mm. Push Force/Piece: 2.5kgs. Finish: Grey. **59** - Size: Ø8 x 10mm. Catch Plate provided. Pull force: 750gms. Finish: White/Mocha/ Grey. **60** - Pull force: MC-US1 - 2.25kgs, MC-US1L - 3.25kgs, MC-US2 - 5kgs, MC-US2L - 5.50kgs, MC-I1 - 2.50kgs, MC-I1L - 2.75kgs.



# JOINERY FITTINGS & SCREWS



## HIGH PRECISION FASTENERS

- Ideal furniture fastener providing high pull-out resistance.
- Manufacture to international specifications and standards.
- Choice of diameters & lengths ensure proper selection for each application.
- Material: C-1022 steel heat treated case hardened or SS304 grade stainless steel.



Pozi Recess CSK Head Chipboard Screw



Pozi Recess CSK Head Screw with Saw-Thread



SS304 Pozi Recess CSK Head Chipboard Screw



Pozi Recess PAN Head Chipboard Screw



Phil Recess CSK Head Drill Screw



Phil Recess PAN Head Drill Screw



M6 Allen Socket CSK Head Screw



Handle Fitting Screw

## STEEL FIX AND MINI FIX



- New Steelfix Housing made out of MS is very strong & usable with existing ebco mini fix screws.

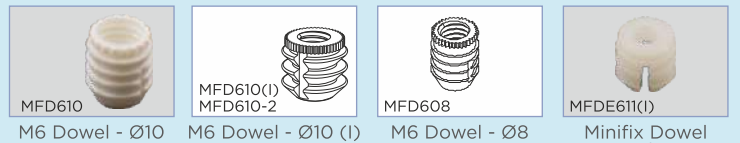
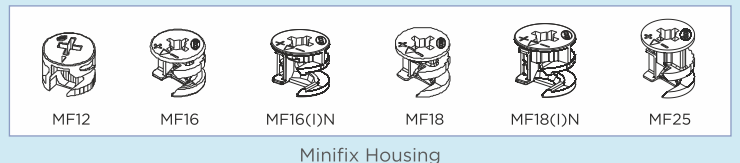
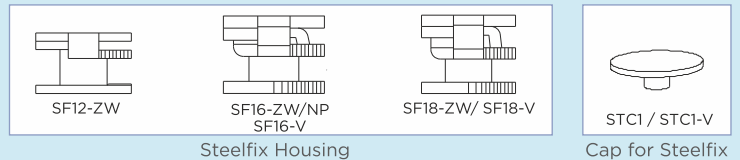



**SELF TAPPING SCREWS (FLAT TIP)**

Size: 3.5x13mm  
Finish: Zinc Plated White



**DOWEL FIX**



Size: Ø12x9mm  
Finish: Zinc Plated White

**04 MODULAR FURNITURE SCREW**



**CAP FOR MODULAR FURNITURE SCREW-7mm ALLEN HEAD**



**M10 PHILIPS HEAD SCREW & CAP**



**07 MAXI CONNECTOR**



**RIGHT ANGLE BLOCK - ECO**



Size : 18 x 20mm  
Finish : Black

**BLOCK CONNECTOR FITTINGS**



Finish: White

**TABLE CONNECTOR**



Finish: Zinc Black

**11 M4 SLEEVE CONNECTING SCREW**



**13 DOWELS**



**MODULAR CLIP**



Finish: Zinc Plated White

**01 SELF TAPPING INSERTS**



**05 WALL PLUG 535**



**08 RIGHT ANGLE BRACKET/SS304**



**12 M4 CONNECTING SCREW- ONE WAY**



**SHELF CAM**



Size: Ø20mm  
Finish: Frosty White / Brown

**02 RIVET NUTS**



**09 STRAIGHT BRACKET - SMALL/ BIG**



Small



Big

**Ø5mm INSERT / INSERT SCREW / INSERT SCREW KNURLED**



**Ø 5 MM PLUG / Ø5MM INSERT**



**CONCEALED SHELF SUPPORT**



Size : ø 15mm  
Finish : Frosty White

**WALL PLUG**



Size: 10x50mm  
Finish: Grey

**06 ANCHOR PLUG WITH SCREW HEX HD/CSK HD**



Anchor Plug Hex Head with Twin Thread

**10 RIGHT ANGLE CONNECTOR**



**RIGHT ANGLE BLOCK**



Finish : Ivory

**03 CROSS NUT / BARREL NUT / SLEEVE NUT**



Cross Nut

Barrel Nut

Sleeve Nut

Anchor Plug with CSK Head

**01** - Size: TN-M4x10, M4x20, M6x11, M6x13, M6x16, M6x20, M8x18, TNC-M6x13/M6x16mm. **Finish:** Zinc Plated White/Yellow. **02** - Size: M3x10, M4x10, M5x11.5, M6x14, M8x16.5. **Finish:** Zinc Plated White. **03** - Size: **Cross Nut** - M6x10, M6x12, M8x10, M10x13. **Barrel Nut** - M6x12. **Finish:** Zinc Plated White. **Sleeve Nut** - M6xØ8x11. **Finish:** Nickel Plated. **04** - Size: For Allen Head - 5x50, 7x50. Phillips Head - 5x25, 5x50. **Finish:** Zinc Plated White. **05** - Size: 5x35, 6x30. **Finish:** White/Grey. **06** - For Hex Head: **Size:** M10x80/100/120/140/ 160mm. For CSK Head: **Size:** M10x80/100/120/140/160mm & M8 x 60/80/100mm **Finish:** Ebco Blue. **07** - **Size:** 65, 100, 150mm. **Finish:** Zinc Plated White. **08** - **Sizes:** 20x20, 40x40, 60x60, 80x80, 20x40, 50x25, 80x26. For SS304: 20x20, 40x40mm. **09** - **Sizes:** Small-30x50, Big-30x70. **Finish:** Zinc Plated White. **10** - **Sizes:** 20x20, 40x40, 25x35. **Finish:** Zinc Plated White & White Matt. **11** - **Sizes:** 21/29/33/41/47mm **Finish:** Nickel Plated. **12** - **Sizes:** Ø5x20/25/30/35/40mm. **Finish:** Nickel Plated. **13** - **Sizes:** Ø6x20/25/30/35 & Ø8x30/35/40mm. **Finish:** Wooden.



# FURNITURE LOCKS

PREMIUM SERIES



## Special Features of Premium Locks

### MASTER KEY SYSTEM:

Each batch of locks can have master key which can open every different lock from the same batch.

### CORE REMOVAL SYSTEM:

Also known as 'Service Key' The core can be removed from a lock and is interchangeable with any type of locks from the premium series.

### SET LOCKS:

Has a possibility of providing set locks (several locks with same key no.) in same or different type of locks from the premium series.

### FOLDING KEY



- Unique Wave key technology.
- Thicker than any furniture lock key, reduces chances of key breaking.
- Easy serviceability.

### FLIP KEY



- Patented Design.
- Double Wave Key System.
- Complete folding.
- Flip to open & use.

### 5000 COMBINATIONS



### PREMIUM LOCKS WITH "ACTIVE PIN SYSTEM"



The Active Pin elevates the level of security to another level. It works instantaneously on unauthorised insertion of a different numbered key.

## 01 MULTI PURPOSE LOCK - ROUND

01 - Size : 22mm.  
Shutter thickness : 16-20mm.

02 - Size : 22mm & 32mm.  
Shutter thickness: 16-20mm. (for 22mm and extended bolt)  
24-30mm. (for 32mm) Extended bolt: extension: 21.5mm & width: 19.5 mm

03 - Shutter thickness: 16-20mm. (for wooden drawer) 0.6-1mm (for metal drawer) can lock as many as 4 drawers with 580mm locking strip.



Straight



Cranked

## 02 SQUARE LOCK



Straight



Extended Bolt

## 03 FRONT MULTI DRAWER LOCK



Wooden Drawer

Steel Cabinet



|| STEEL FURNITURE LOCKS

**04** CAM LOCK

Standard      Threaded ||

**05** CAM LATCH - STEEL FURNITURE ||

**09** PEDESTAL LOCK

Wooden Drawer      Steel Drawer ||

**06** WALK IN SLIDING LOCK

**10** GLASS DOOR LOCK

Single      Double

**07** PUSH & TURN LOCK

**11** AUTO LATCH LOCK

**08** PUSH LOCK

**12** WARDROBE LOCK - 2 POINT - INSET/  
WARDROBE LOCK - 3 POINT

3 Point Lock      2 Point Lock

**13** STORAGE LOCK - 2 POINT (INSET) 1200mm

**14** LOCK KNOB ADAPTOR

**15** LOCK CORE WITH 2 KEYS / 3 KEYS

**04** - Size: Standard 22mm & Threaded 25 / 30mm. **05** - Size: 20mm. 90° rotary cam movement. Pad lock shackle diameter: min. 4mm - max. 6mm. **06** - Finish: Nickel Plated, Champagne & Special. Cam: 37/45mm. **07** - Size: 22mm. Shutter thickness: 16-20mm. **08** - Size: 22mm. Shutter thickness: 16-20mm. **09** - Size: 22mm. Shutter thickness: 16-20mm. (for wood) & 0.6-0.9mm (for steel). **10** - Sizes: 9mm & 12mm. Shutter thickness: 4-7mm. (for single glass shutters) & 4-10mm (for double glass shutters) **11** - Size: 22mm. **12** - Size: 22mm & 32mm. Rod size: 1250mm.(for 22 & 32mm.) & 1500mm.(for overlay model). **13** - Applicable for vertical openable inset doors as well as horizontal wide drawers (upto 1200mm). Rod size: 600mm. **14** - Lock Knob Adaptor is ideal for wardrobes, drawers and cabinets. Its oval design can be adaptor to any lock from Ebco Premium range. **15** - Standard core applicable to any lock from the Premium range.





# FURNITURE LOCKS

## Secutek LOCKS

- Upto 200 combinations.
- Size: 20mm
- Option of Master Key system.
- Option of set locks.
- Die cast Body.

### 16 MULTI PURPOSE LOCK - ROUND

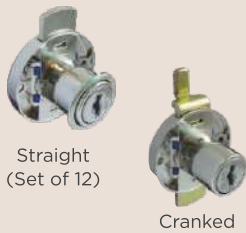

### 19 CAM LOCK



### 23 MORTISE LOCK FOR SLIDING DOOR



### 17 SQUARE LOCK



### 21 PUSH LOCK



### 25 26

LOCK RECEIVER PLATE BRACKET FOR BOTTOM MOUNTING DR. SLIDE & FULL PANEL DR. SLIDE



### 18 FRONT MULTI DRAWER LOCK



### 22 PEDESTAL LOCK



### KEYS FOR SECUTEK LOCKS



# SECUTEK LOCKS & TARGET LOCKS



- Up to 200 combinations
- Click action mechanism
- Option of set locks
- Sheet Metal body
- Options of metal key/ key with plastic cap

### 30 CAM LOCK



### 27 MULTI PURPOSE LOCK - ROUND



### 31 PUSH LOCK



### 32 PEDESTAL LOCK



### 28 SQUARE LOCK



### 33 MORTISE LOCK FOR SLIDING DOOR



16 - Size: 22mm. Available with Metal Key. 17 - Size : 22mm / 32mm. Available with Metal Key & folding Key. 18 - Size: 22mm. Height: 480mm & 580mm. 19 - Size: Standard 22mm and Threaded (16 / 25 / 30mm). 20 - Size: 20mm. Suitable for metal thickness: 0.6mm - 0.9mm. 21 - Size: 22mm. 22 - Size: 22mm. Available with metal key. 23 - Size: 22mm. 24 - • Having 6 lever construction & bolt operation from either side. • Can be mounted for vertical or horizontal operation. • Now available with longer key. 25/26 - Finish: Ivory / Zinc Plated Yellow. 27 - Size : 22mm. 28 - Size : 22mm & 32mm. Shutter thickness: 16-20mm. 29 - Size : 480mm & 580mm. Shutter thickness: 16-20mm. 30 - Size : Standard 22mm & Threaded (16 / 25 / 30mm). 31 - Size: 22mm. Shutter thickness: 16-20mm. 32 - Size: 20mm. Shutter thickness: 16-20mm. 33 - Size: 22mm. Shutter thickness: 16-22mm.

|| STEEL FURNITURE LOCKS

### 29 FRONT MULTI DRAWER LOCK (480MM & 580MM)



### KEYS FOR TARGET LOCKS





**34** SecuRite CUPBOARD LOCK

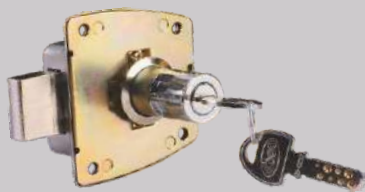

Dimple Key



Brass Key

- Option of Dimple Key and Brass Key to choose from
- Master Key System (Optional)
- Stainless steel cover : non-magnetic and rivet-less.
- Long latch for additional safety – 20mm (For Cupboard Lock) & 15mm (For Drawer Lock)
- Click Action Mechanism
- Reversible Key insertion

**37** CUPBOARD LOCK FOR - STEEL CABINET - 2 II



CUPBOARD LOCK - STEEL CABINET II



**35** SecuRite DRAWER LOCK



Dimple Key



Brass Key

**36** SLIDING WARDROBE LOCK



SLIDING WARDROBE LOCK (SIDE MOUNT) L/R

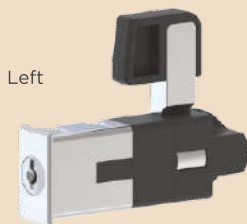

Left

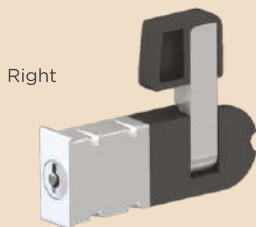

Right

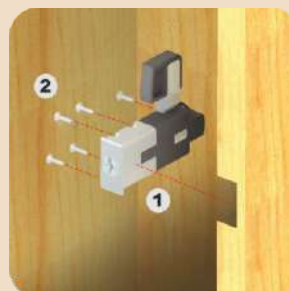

Finish : Nickel Plated



LOCKED



UNLOCKED

STEEL CABINET HANDLE



STEEL CABINET LOCK CUM HANDLE



5000 COMBINATION

CUPBOARD SLIDING LOCK



Size : 18-25mm/ 32-38mm  
Finish : Nickel Plated

**34** - Size: For Dimple Keys : 20, 23, 25, 29, 32, 35mm.

For Brass Keys : 20, 23, 25, 29, 32, 35mm.

**35** - Size: For Dimple Keys : 16, 20, 23, 25, 29mm.

For Brass Keys : 16, 20, 23, 25, 29mm.

**36** - Size: 19, 25, 32,35mm

**37** - Cut Out Dia.: 65.5 x 93.5 mm. Thickness : 0.6-1mm



# FURNITURE LOCKS

## 4 DIGIT COMBINATION LOCKS

- Four digit combination lock for keyless operation.
- Ideal Applications:
  - Corporate Office, BPOs, Banks.
  - Home Furniture - Wardrobe, Kitchen, etc.
  - Lockers - Club, Gym, Hostel, Factory, etc.
  - Retail Showrooms.
  - Display Units - Watches, Jewellery, Gadgets, etc.
- Replace any standard furniture lock to get instant keyless access.
- Once unlocked, the housing doubles as a knob; just rotate 90° to unlatch.
- The combination can be reset to any four digit number, providing up to 10000 possible combinations.
- Two levels of code setting: Combi-Public and Combi-Personal.
- Resolve forgotten secret code easily & rapidly with secret code retriever key.



Note : Operating Instructions - Combination Lock Scan Here.

## 4 DIGIT COMBINATION LOCK - WOOD (L/R)



Size: 16 - 20mm  
Finish: Black

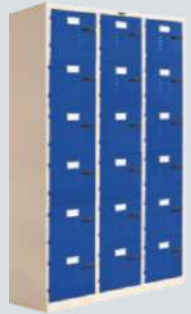

## 4 DIGIT COMBINATION LOCK - PEDESTAL (L/R)



Size: 16 - 20mm  
Finish: Black



## 4 DIGIT COMBINATION LOCK - STEEL CUPBOARD



## 4 DIGIT COMBINATION LOCK - WARDROBE 2 POINT INSET



Height : 2.4mm (1.2mm x 2)  
For door thickness: 16 - 20mm

## 4 DIGIT COMBINATION LOCK - 2 POINT SWING (WITH ROD)



Size: For 16 - 20mm

## STEEL FURNITURE LOCKS

## SPECIALITY LOCKS & STEEL FURNITURE LOCKS

### 4 DIGIT COMBINATION LOCK - WOOD (VERTICAL) (L/R)

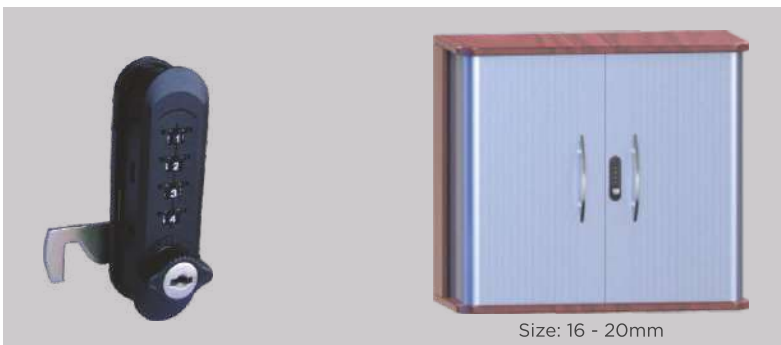

Size: 16 - 20mm

### 4 DIGIT COMBINATION LOCK - ZINC WOOD



Size: For 16 - 20mm



3 Digit Combination Lock - Wood (Left) with cam



3 Digit Combination Lock - Pedestal (Right) with pin



4 Digit Combination Lock - Wood (Left) with cam



4 Digit Combination Lock - Pedestal (Right) with pin





## Pole Shelving System



## FEATURES

- This versatile Display System is equally suited for brand retail stores (Clothing, Apparels, Department) as well as walk-in wardrobes at home.
- It's highly flexible design enables to change the combination / layout of display without actually removing the pole systems installed.
- Multiple Adapter brackets can be chosen for Hangers, Shelves, Cabinets, Tilting Shelves, etc as per your desired application.
- Aluminium sections and die cast parts ensures strength and stability.
- Flexibility to mount the pole from floor to wall / ceiling as per the design requirement.
- Finish available: Brown / Silver / Champagne / Gold / Special Finish.



# RETAIL DISPLAY SYSTEMS

## POLE SHELVING SYSTEM APPLICATIONS



## DISPLAY SHELVING SYSTEM - VERTICAL

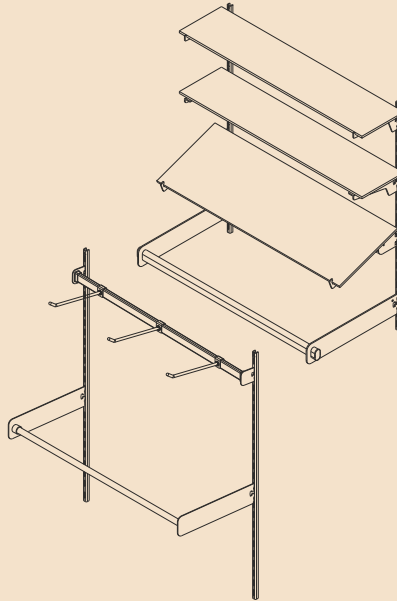

- Elegantly designed to suit different needs.
- Available in a variety of models and sizes.
- It is ideal if you have different items to display from time to time.
- Specially designed to impart maximum strength and to eliminate play.
- A unique stabilizer screw and nut holds the shelf in place.
- Available with an Aluminium Track for light weight load and Steel Track for heavy load.
- The tracks which support the shelves are screwed on to the wall, so that they blend well with the decor.
- Available for glass, wood shelves and hanger systems.
- Track, Wood Shelf Bracket, Glass Shelf Bracket, Hanger Holder Brackets, Hanger Rack, Rod Bracket and Glass Shelf Support with Screw & Nut are also available in **SS304**.

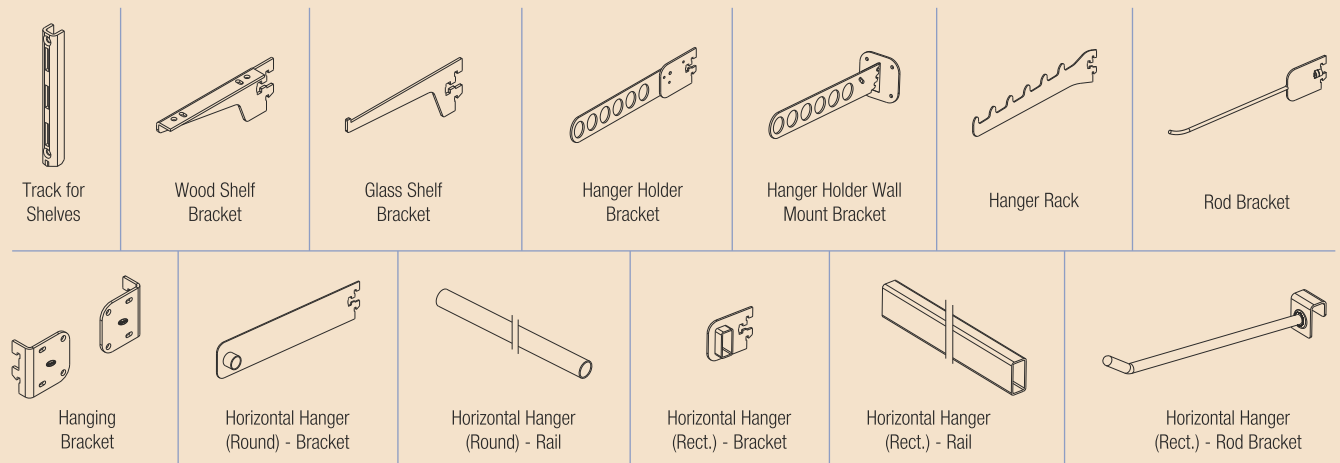

## DISPLAY SHELVING SYSTEM - HORIZONTAL

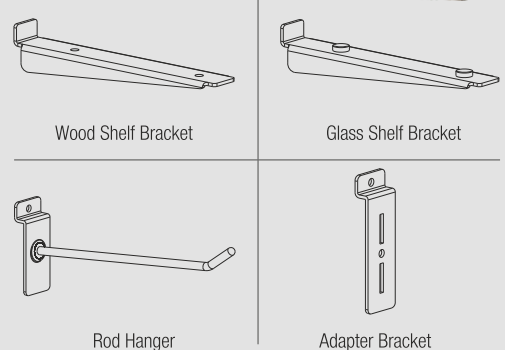





# WINDOW, DOOR & GLASS HARDWARE

**01** FRICTION STAY - HI LOAD (SS304)



**04** CONCEALED CORNER HINGE 80 / 120 (WITH BEVELLED GROOVE)

Load Capacity: 80/120 kg.  
Shutter Width: 4ft (1220mm)  
Shutter Height: 8ft (2438mm)  
Stack Height: 21mm



**05** WINDOW HANDLE - HEAVY (L/R)



**08** MORTISE WINDOW HANDLE -3



## FEATURES

- Made of AISI 304 stainless steel.
- Pressure adjustable brake for stopping.
- Can be used for side hung horizontal axis opening ventilators, as well as top hung vertical axis opening windows.
- Self cleaning design.
- Max. opening angle: 90°
- Stack Height - 15mm (for 8" to 14") 18mm (for 16" to 28")
- Applicable in wooden, UPVC or aluminium windows.
- Also available in independent left and right hand working for better closing and alignment.
- Load capacity: 13-50Kg

**06** ALUMINIUM WINDOW HANDLE - DELUXE 2



**09** WINDOW-DOOR HANDLE WITH PUSH LATCH



**02** FRICTION STAY 1319 (SS304)



Load Capacity:  
10" (250mm) - 18kg,  
12" (300mm) - 22kg,  
14" (350mm) - 25kg  
Stack Height: 19mm.  
Max. Opening Angle: 88°

**07** MORTISE WINDOW HANDLE WITH LOCK 3



**03** FRICTION STAY HEAVY DUTY (SS304)



Load Capacity: 80 kg.  
Stack Height: 16.5mm  
Max. Opening Angle:  
25° (for 20")  
20° (for 24" & 28")

**01** - Size: 8" (205mm) 10" (255mm) , 12" (305mm), 14" (355mm), 16" (405mm), 20" (510mm), 24" (610mm), 28" (710mm). **02** - Size : 10" (250mm), 12" (300mm), 14" (350mm). **03** - Size : 20" (500mm), 24" (600mm), 28" (700mm). **04** - Load : 80/120 Kgs. **05** - Finish: White/ Black **06** - Finish: White/ Black. **07** - Finish: White/ Black. **08** - Finish: White/Black. **09** - Finish: White/ Black.

**TRANSMISSION LOCK STRIP FOR SWING DOORS**



- Available in three lengths (600,1000,1600mm) with two & four locking points.
- Can be used for both left & right hand locking windows.
- Compatible with Ebco Mortise Window Handle with Lock (AWH-DML3/AWH-DM3)

**TRANSMISSION LOCK STRIP FOR SLIDING DOORS**

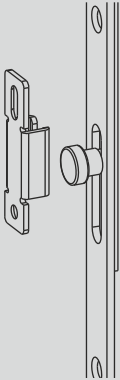

- Available in three lengths (600,1000,1600mm) with two & four locking points.
- Can be used for both left & right hand locking windows.
- Compatible with Ebco Mortise Window Handle with Lock (AWH-DML3/AWH-DM3)

**10 WINDOW HANDLE (LOW / LOW 4-HOLE)**



**11 WINDOW HANDLE - EURO**



**12 EURO WINDOW HANDLE - 4 HOLE**



**13 CRESCENT LATCH**



**14 SLIDING WINDOW LOCK 1925**



With Key

Manual

**15 SLIDING WINDOW LATCH**



**16 SLIDING WINDOW LATCH - CLICK FIT**

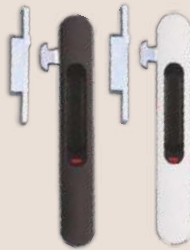

**17 SLIDING WINDOW LATCH - CLICK FIT LONG**



**18 SLIDING WINDOW LATCH - EASY**



**SLIDING WINDOW LATCH CATCHES**

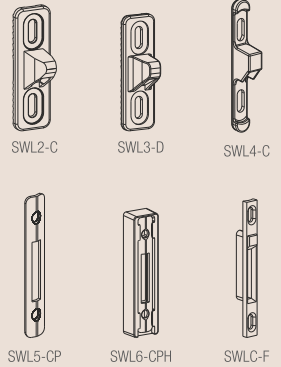

**19 ALUMINIUM DOOR HANDLE**



**CONNECTOR ROPE FITTING**



**20 ALUMINIUM CORNER CLEAT**



**10 - Finish:** Brown/Black/Window White/Silver/White Matt/ Champagne Gold. **11- Finish:** Brown/Black/Window White/Silver/White Matt. **12 - Finish:** Brown/Black/Window White/Silver/White Matt. **13 - Finish:** Brown/Black/Window White/Silver. **14 - Finish:** (with key) White/Brown/Grey/Black, (manual) White/Brown/Black. **15 - Finish:** Brown/Black/Window White/Silver/Champagne Gold. **16 - Finish:** Window White/Black/ Champagne/Brown. **17 - Finish:** Window White/ Black/ Champagne/ Brown. **18 - Finish:** Brown/Black/Window White/ Silver/ Champagne Gold. **19 - Finish:** White/Black. **20 - Size:** Big-36mm x 48mm thk. Small-22mm x 10.4mm thk.

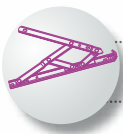

# WINDOW, DOOR & GLASS HARDWARE

## SLIDING DOOR FITTING (125KGS)



SLIDING DOOR FITTINGS - STANDARD



SLIDING DOOR FITTINGS - FLUSH



SLIDING DOOR FITTINGS - GLASS



Load capacity:  
40, 80 & 120kgs  
Finish: Black / Grey

SOFT CLOSE KIT  
FOR SDF 125

## SLIDING DOOR SYSTEM 100 – SOFT CLOSE (FOR WOODEN / AL. FRAME & GLASS DOOR)



### FEATURES

- Designed for Wooden, Al. Frame and Glass Door.
- High precise roller, stable, smooth & silent sliding.
- Easy to install and remove.
- Door Width : 580 -1200mm
- Door Weight : ≤80Kgs
- Door Thickness : 35-50mm (For Wooden & Al. Frame Door) 8-12mm (For Glass Door)

Top mounting rail

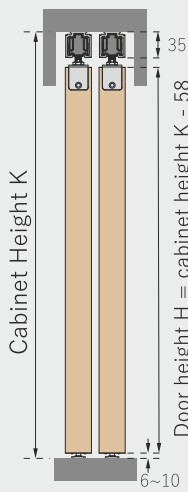

Wooden Door

Top mounting rail

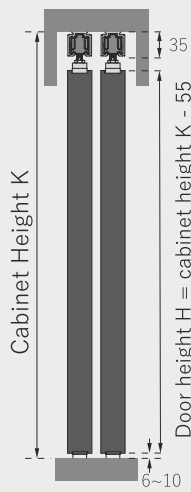

Al. Frame Door

Top mounting rail

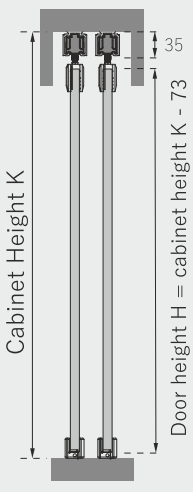

Glass Door

## LINKED SLIDING PARTITION SYSTEM 100 – SOFT CLOSE (FOR WOODEN & AL. FRAME DOOR)



### FEATURES

- Designed for Wooden & Al. Frame Doors.
- High precise roller, stable, smooth & silent sliding.
- Easy to install and remove.
- Door Width : 580 -1200mm (single) and 820 -1200mm (double)
- Door Weight : ≤80Kgs
- Door Thickness : 35-50mm

2+1 Door



Wooden Door

3+1 Door

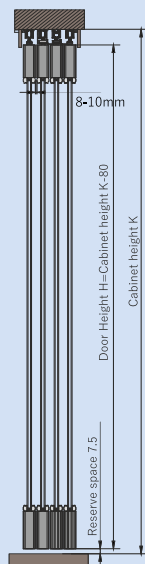

2+1 Door

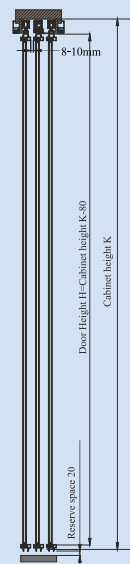

Al. Frame Door

3+1 Door

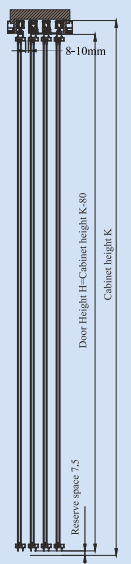



**2 WAY SYNCRO SLIDING PARTITION SYSTEM 100 – SOFT CLOSE  
(FOR WOODEN & AL. FRAME DOOR)**



**FEATURES**

- Designed for Wooden & Al. Frame Partition Doors which can be opened & closed synchronously.
- High precise roller, stable, smooth & silent sliding.
- Easy to install and remove.
- Door Width : 580 - 1200mm (single) and 820 -1200mm (double)
- Door Weight : ≤80Kgs
- Door Thickness : 35-50mm

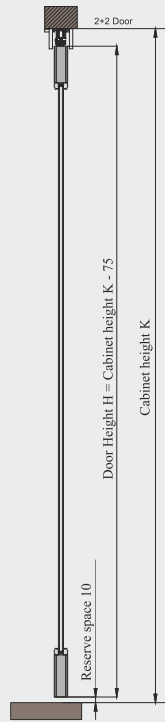

Wooden Door

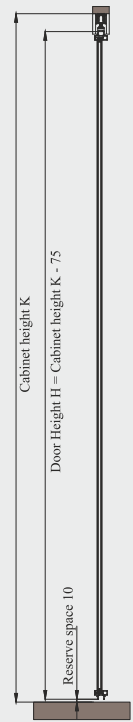

Al. Frame Door

**WOOD SLIDING FOLDING FITTING**

Min. Door Thickness: 40mm  
Load capacity: 60Kgs/panel

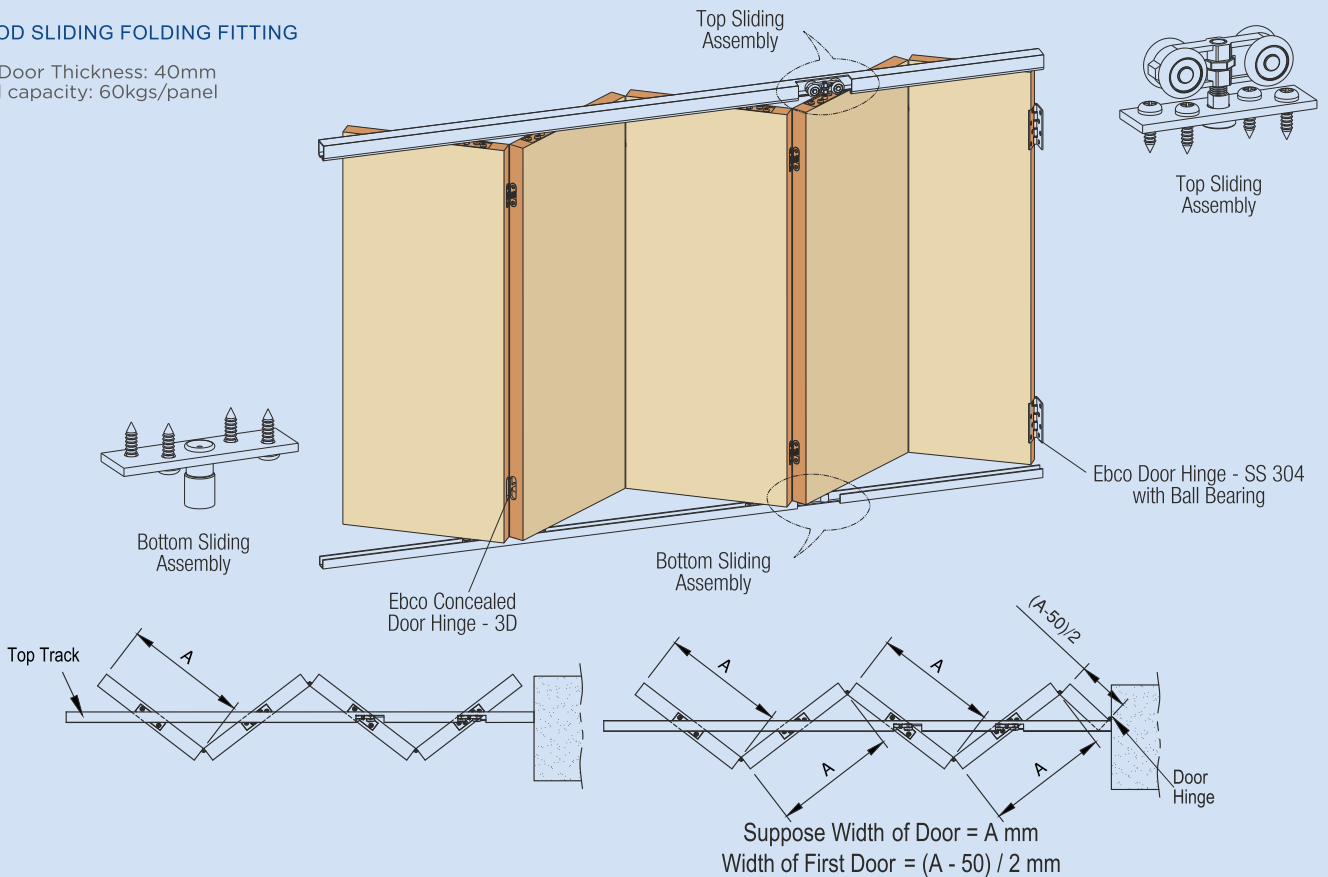

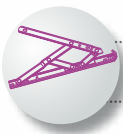

# WINDOW, DOOR & GLASS HARDWARE



PRESTO - DOOR KNOB LOCK **PRESTO**

Anthracite

### Available Finish



Nickel Satin

Antique Brass

Brushed Steel

Chrome Plated

### BORING KIT FOR PRESTO LOCK



Size : 23mm & 42mm

### SLIDING DOOR LOCK - WOOD, SWING DOOR LOCK - WOOD / ALUMINIUM.



Sliding Door Lock



Swing Door Lock



Opening Tool



**TO OPEN:**  
SIMPLY PRESS DOWN  
ON THE TOP CAP



**TO CLOSE:**  
LET GO OF THE TOP CAP

### DOOR HINGES - SS 304 (WITH 2 BALL BEARING)



- Made out of SS304, the hinges are designed with precision ball bearings.
- Size: 75x75x2.0mm  
125x75x2.5/3.0mm  
100x75x2.5/3.0mm

### BUTT HINGES SS 304 – WELDED (W/O BEARING)



- Made out of SS 304
- Suitable for doors of different sizes and weight.
- Available Sizes : 4 x 12", 5 x 12", 3 x 12"
- Available with screws.

### CONCEALED HINGE - 3D



- Ideal for flush wooden door applications.
- 3-dimensional adjustment function allows vertical, horizontal and depth adjustment after hinge is installed.
- 300,000 cycles tested.
- Cover hides all screw for aesthetic looks.
- For 3D, Max. Door Weight, Min Door Thickness (T) & Width (W): For 40Kgs - 35mm (T) & 850mm (W), For 80Kgs - 40mm (T) & 1000mm (W), For 120Kgs - 45mm (T) & 1400mm (W). Max. Opening Angle: 180°.

### SECURITY DOOR LATCH



- For Main doors: apartments, villas & hotels.
- Open or block the door with easy to flip turn designed Security door latch.
- Only attaches to the door frame, no fitting on the door
- Comes with packing (optional) for thick doors.
- Minimum frame width: 38mm
- Finish: Brown/Anthracite/Transparent Gold

### DOOR VIEWER



- This door viewer gives ultra clear view with 165° wide angle.
- Door Thickness : 25 - 60mm
- Drill Hole : Ø25mm
- Finish : Brushed Steel and Antique.

### DOOR OPENER BRACKET

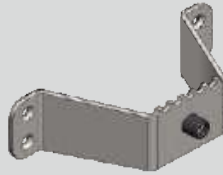

- EbcO Door Opener Bracket is an ideal solution, which eliminates the use of hand to open the door. Ideal for offices, hospitals, retail outlets, etc.
- Prevents contamination and spread of germs/viruses.
- Wall bumper to protect the wall from damage.
- Curved tooth design ensures better grip.
- To be used in commercial latch-less doors.

### DOOR LATCH -SS 304



### TURN LATCH



## DOOR CLOSERS



**21** - DC 101 Door Width : 850 mm. Door Weight : 65 kgs. Type : Hold Open. Opening Angle : 180°. DC 101-B2 Door Width : 800 mm. Door Weight : 45 kgs. Type : Non Hold Open. Opening Angle : 180°. **22** - DC 201 Door Width : 1050mm. Door Weight : 85 kgs. Type : Hold Open. Opening Angle : 180°. DC 201-B Door Width : 900mm. Door Weight : 65 kgs. Type : Non Hold Open. Opening Angle : 180°. DC 201-C Door Width : 1050mm. Door Weight : 85 kgs. Type : Without Hold Open. Opening Angle : 180°.

### 21 DOOR CLOSER - DC 101 DOOR CLOSER - DC 101-B2

5,00,000  
CYCLE TESTED



### 22 DOOR CLOSER - DC 201 DOOR CLOSER - DC 201-B DOOR CLOSER - DC 201-C

5,00,000  
CYCLE TESTED

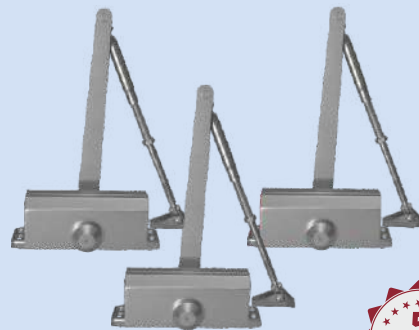

DC 201



DC 201-C

DC 201-B

DC 201-C







# WINDOW, DOOR & GLASS HARDWARE

**23** DOOR CLOSER - DC 301  
DOOR CLOSER - DC 301-B

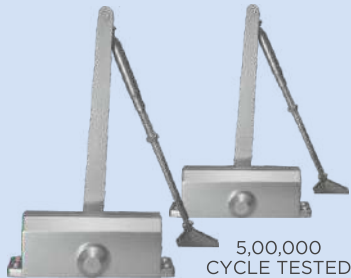

5,00,000  
CYCLE TESTED

**24** DOOR CLOSER - PELMET ARM



3,00,000  
CYCLE TESTED

**25** DOOR CLOSER - DC 1001

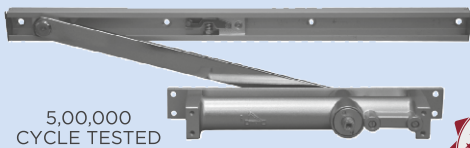

5,00,000  
CYCLE TESTED



**26** DOOR CLOSER - DC 1002



5,00,000  
CYCLE TESTED



**23** - DC 301 Door Width : 1200mm. Door Weight : 105 kgs. Type : Hold Open. Opening Angle : 180°. DC 301-B Door Width : 1200mm. Door Weight : 105 kgs. Type : Non Hold Open. Opening Angle : 180°. **24** - Door Width : 500 - 1000mm. Door Load Capacity: 30 - 80 kgs. Type : Hold Open. Opening Angle : 130°. **25** - Door Width : Up to 850mm. Door Weight : 65 kgs. Type : Hold Open. Opening Angle : 180°. **26** - Door Width : Up to 1000mm. Door Weight : 85 kgs. Type : Hold Open. Opening Angle : 150°.

## FLOOR SPRING & ACCESSORIES



### FLOOR SPRING - 84

- 20,00,000 cycle tested
- Universal Application - Load Adjustment From: 80kg - 100kg (For DFS 84-100C model) and 100kg - 130kg (For DFS 84-130C model)
- Max. Door Width: 900-1000mm (For DFS 84-100) and 1000-1100mm (For DFS 84-130).
- Max. Opening Angle - 130°
- 90° Hold Open Angle



DFS 84-100C



DFS 84-130C



### FLOOR SPRING - 75V

- 20,00,000 cycle tested
- Universal application - Load adjustment from 60 to 150 kg
- Door Width - 1100mm
- Max opening angle - 360°
- Hold Open angle at 90° and at any point between - 105° to -105°



**27** FLOOR SPRING - 60



**28** FLOOR SPRING - 90



**29** FLOOR SPRING - 250



FLOOR SPRING DOOR ACCESSORIES (DFS-A1)



FLOOR SPRING DOOR ACCESSORIES (DFS-A2)



**30** BOTTOM PIVOT (DPF4-01)



**31** TOP PIVOT (DPF4-02)



**PATCH FITTINGS (SS 304)**  
Glass Thickness: 10 - 12mm  
Finish: Brushed Steel

**BOTTOM CORNER PATCH**  
DPF1-01



**TOP CORNER PATCH**  
DPF1-02



**CORNER 'L' PATCH WITH PIVOT**  
DPF1-04



**CENTRE LOCK**  
DPF2-01



**STRIKE PATCH FOR CENTRE LOCK**  
DPF2-02



**SINGLE CONNECTOR PATCH**  
DPF3-01



**CORNER 'L' PATCH WITHOUT PIVOT**  
DPF3-02



**PATCH FITTINGS**  
Finish: Brushed Steel

**OVER PANEL PATCH WITH PLATE**  
DPF1-03



**QUAD CONNECTOR PATCH**  
DPF3-03



**DOUBLE CORNER PATCH**  
DPF3-04



**32** AUTO CLOSING PATCH  
DACPI-100



**27** - 5,00,000 cycle tested. Max. open angle : 116°. Hold open angle: 90° Max. Door Width : 700mm. Max. Door Weight: 60 kgs. **28** - 5,00,000 cycle tested. Max. open angle : 116°. Hold open angle: 90° Max. Door Width : 800-1000mm. Max. Door Weight : 90 kgs. **29** - 5,00,000 cycle tested. Door Width : 1200mm. Max. open angle : 130°. Hold open angle: 90°. Max. Door Weight : 250 kgs. **30** - To be used directly on the floor without floor spring. **31**- Top receiver pivot for wooden or ceiling installation. **32** - Max. open angle : 360°. Hold open angle: 90° Max. Door Width : 1100mm. Max. Door Weight: 100 kgs.



# WINDOW, DOOR & GLASS HARDWARE

## GLASS CONNECTORS (SS 304)

Glass Thickness: 8 - 12mm  
Finish: Brushed Steel/ Polished SS

### 90° WALL TO GLASS OR FLOOR TO GLASS CONNECTOR



### 90° WALL TO GLASS CONNECTOR



### 90° GLASS TO GLASS CONNECTOR



### 135° WALL TO GLASS CONNECTOR



### 135° GLASS TO GLASS CONNECTOR



### 180° WALL TO GLASS CONNECTOR



### 180° GLASS TO GLASS CONNECTOR



### 3 WAY GLASS TO GLASS CONNECTOR



## SHOWER HINGES (SS 304)

Glass Thickness: 8 - 12mm  
Max. Load: 54kgs.  
Finish: Brushed Steel/ Polished SS

### SHOWER HINGE 90° (WALL TO GLASS) - T TYPE



### SHOWER HINGE 90° (WALL TO GLASS) - L TYPE



### SHOWER HINGE 135° GLASS TO GLASS



### SHOWER HINGE 180° GLASS TO GLASS



### SHOWER HINGE 90° GLASS TO GLASS



## GLASS DOOR LOCKS (SS 304)

Finish: Brushed Steel  
Glass Thickness: 10mm - 12mm

### OPENABLE GLASS DOOR LOCK - GLASS TO WOOD - SS304



### OPENABLE GLASS DOOR LOCK - GLASS TO GLASS - SS304



### OPENABLE GLASS DOOR LOCK - GLASS TO GLASS - SS304 - KNOB



### SLIDING GLASS DOOR LOCK - GLASS TO WOOD - SS304



### SLIDING GLASS DOOR LOCK - GLASS TO GLASS - SS304



## GLASS DOOR HANDLES (SS 304)

Finish: Brushed Steel

### 33 DOOR HANDLE - D

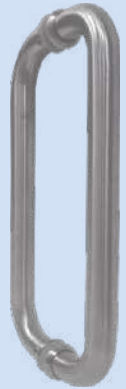

### 34 DOOR HANDLE - H

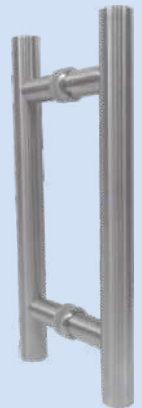

33 Sizes	Hole to hole
ØDia(mm)	ØDistance(mm)
Ø19mm X	250mm
Ø22mm X	300mm
Ø25mm X	450mm
Ø32mm X	600mm

34 Sizes	Hole to hole
ØDia(mm)	ØDistance(mm)
Ø22mm X	150mm
Ø25mm X	200mm
Ø25mm X	300mm
Ø32mm X	450mm
Ø32mm X	750mm



### GLASS SLIDING FOLDING SYSTEM 2 (SS 304)



Max. Door Width: 800mm  
 Max. Door Height: 2000mm  
 Max. Door Weight: 60kgs each  
 Finish: Brushed Steel

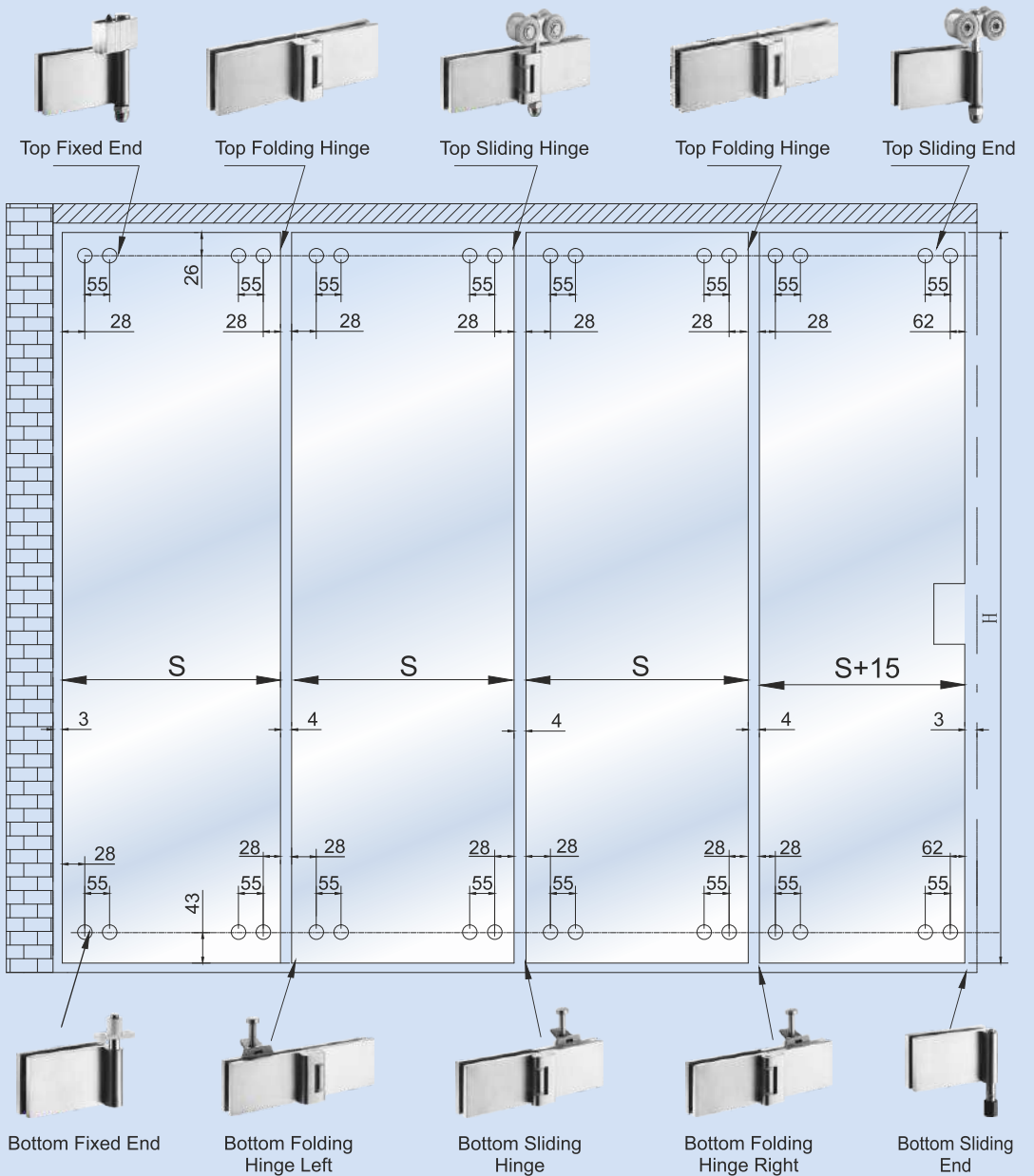



# WINDOW, DOOR & GLASS HARDWARE

## SHOWER SLIDING FITTINGS - RECTANGULAR

- Made out of SS304
- Max. load - 60kgs.
- Suitable for 8mm to 10mm glass thickness .
- Max. installation length 2 mtrs.
- Glass to be toughened after making the holes.



## SHOWER FITTINGS Finish: Brushed Steel/SSS/ Polished SS

WALL TO TUBE CONNECTOR - 19MM



TUBE TO GLASS CONNECTOR - 19MM



TUBE TO TUBE CONNECTOR - 19MM



SHOWER ROD Ø 32 X 24



SHOWER DOOR KNOB



DOOR HANDLE - DIA 19MM X 150MM X 450MM



DOOR STOPPER



## PLASTIC SEALS

35

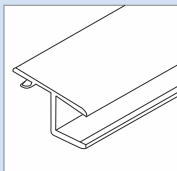

PVC SEAL BPS1-10

36

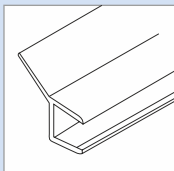

PVC SEAL BPS2-12mm

37

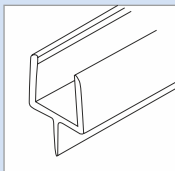

BOTTOM PVC SEAL BPS3-08/12mm

38

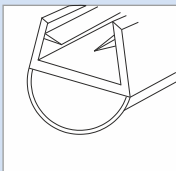

PVC SEAL BPS7-S08/S12mm

39

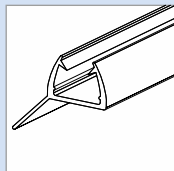

PVC SEAL PS2-10/12

40

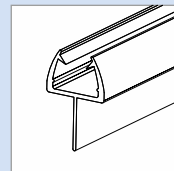

BOTTOM PVC SEAL PS3-12

41

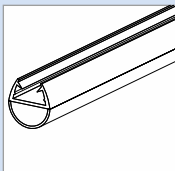

PVC SEAL PS7-S10/S12

35 - Glass Thickness: 10mm (BPS1-10mm). 36 - Glass Thickness: 12mm (BPS2-12mm). 37 - Glass Thickness: 8 & 12mm (BPS3-08/12). 38 - Glass Thickness: 8 & 12mm (BPS7-08/12). 39 - Glass Thickness: 10 & 12mm (PS2-10/12). 40 - Glass Thickness: 12mm (PS3-12). 41 - Glass Thickness: 10 & 12mm (PS7-S10/S12). 42 - Glass Thickness: 8-12mm. Finish: Brushed Steel/SSS/Polished SS. 43 - Glass Thickness: 8-12mm. Finish: Aluminium Polished.

## SLIDING GLASS DOOR HANDLE

42

SLIDING GLASS DOOR HANDLE - SS304



SGD1 BS/PS

43

SLIDING GLASS DOOR HANDLE - ALUMINIUM



SGD2 AP



SGD3 AP

## Furniture Fittings Care to last long

# DO'S & DON'TS



Install the products as per fitting instructions provided.



Ensure proper adjustments/alignments and after installation (including floor level and cabinet dimensions).



Hardware installation to be carried out only after civil & painting work is completed.



Always use a clean and dry cloth to wipe any part of the hardware. May be done twice a month.



For materials such as stainless steel etc., always use a special cleaner (if available) or clean water in a soft cloth or sponge (slightly damp, not wet) and re-wipe the area with a dry cloth once done.



If unsure about product installation, please download fitting instruction from [www.ebco.in](http://www.ebco.in) or contact our authorized distributor/dealer or company directly for assistance.



Do not use any kind of cleaning agents such as Thinner, Turpentine Oil, Colin, Detergent Solutions etc. to clean hardware components. Do not apply Paints, Polish, Varnish.



Do not abuse the product- i.e, hammering and forcefully exceeding the opening angles, forcefully pushing the channels without considering/checking for side gaps, exceeding the specified load capacity, exposing to heat or fire etc. (Do not alter or modify a product)



Do not lubricate the products without first checking the applicability of the lubricant with the company.



Do not open a product to inspect it's internal parts without consulting an authorized distributor or the company directly.



Do not let saw dust and concrete rubble/dust enter any components of the hardware.



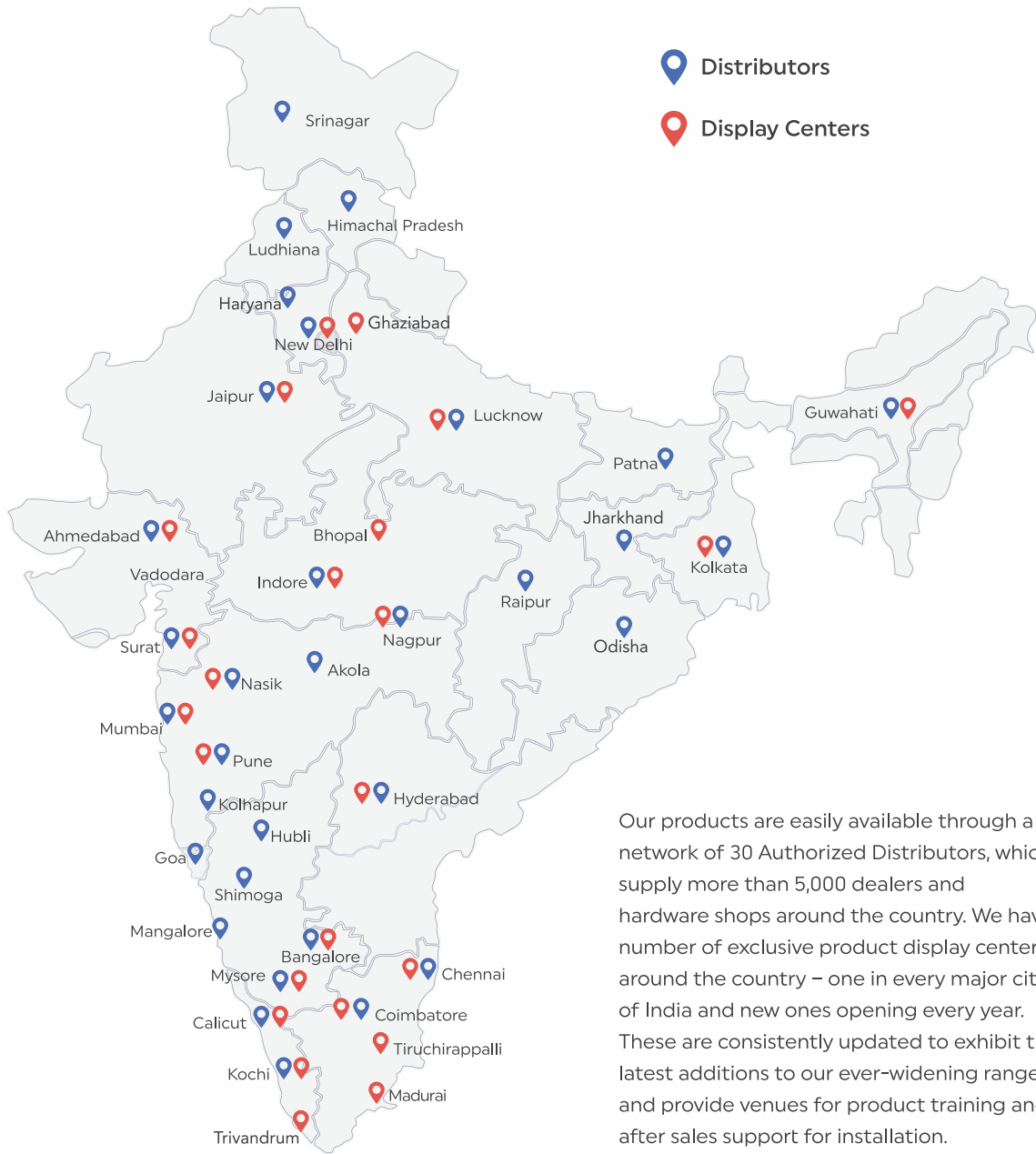

Our products are easily available through a network of 30 Authorized Distributors, which supply more than 5,000 dealers and hardware shops around the country. We have number of exclusive product display centers around the country – one in every major city of India and new ones opening every year. These are consistently updated to exhibit the latest additions to our ever-widening range; and provide venues for product training and after sales support for installation.



- BROCHURES
- LEAFLETS
- CATALOGUES